

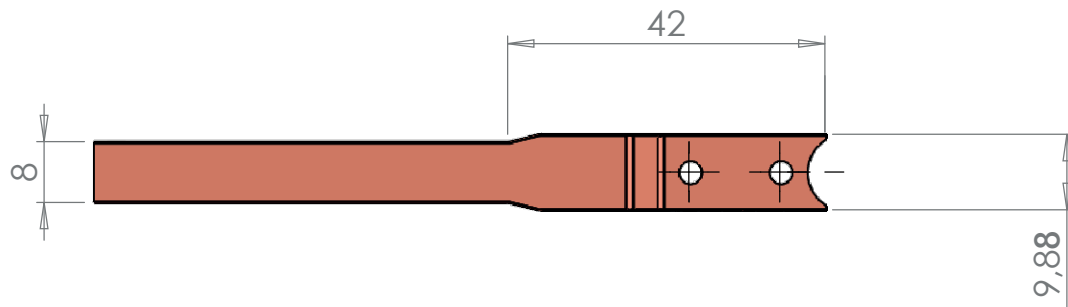

This document must not be copied without Carbox AB written permission, and the contents thereof must not be imparted to a third party nor be used for any unauthorized purpose. Contravention will be prosecuted.

BGB NO: C4064-01

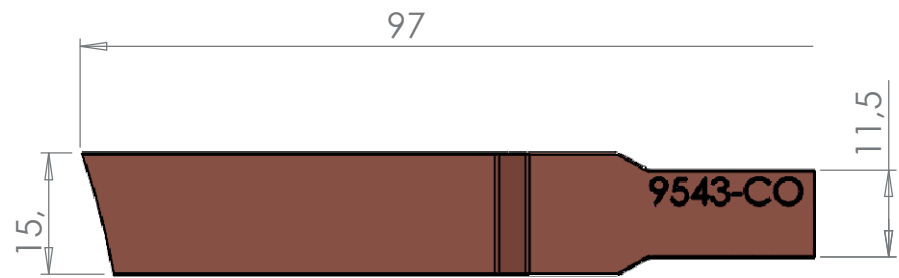
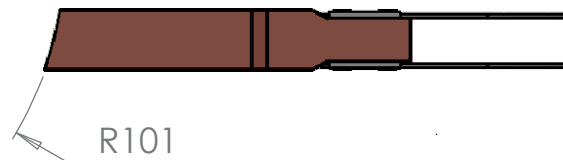
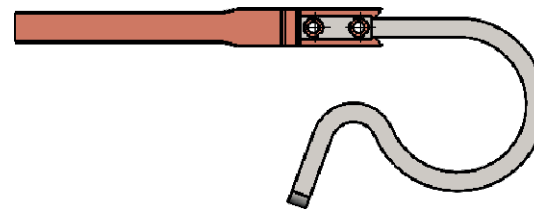
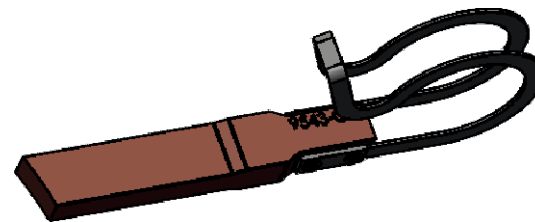

REVISIONS				
ZONE	REV.	DESCRIPTION	DATE	APPROVED
	A	Changed material from CU50M to CMB6	2018-10-18	EB
	B	Changed rivet hole Ø3 to 3,2mm. Added tolerance of lenght	2021-02-24	JS



Drawn By	Last Changed Date	Surface Treatment	General tolerance	CAD-System
Approved By	Date <b>2018-03-16</b>	General Surface Roughn.	Material <b>CMB6</b>	Drawing Size <b>A4</b>
 <b>SCHLEIFRING</b>		Title <b>V90 Ground brush Vestas no: 753741</b>		Scale <b>1:1</b>
		Drawing No <b>9543-CO-REVB</b>		Sheet <b>1 (2)</b>

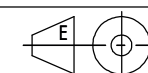

ITEM NO.	DESCRIPTION	QTY.
1	V90 Ground brush Vestas no: 753741	1
2	TIN PLATED COPPER BRAIDFLEXIBLE 5X1 SECTION X 200MM	1
3	RED GLASS SLEEVE INSULATION 5 mm	1
4	Terminal SRS M6	1

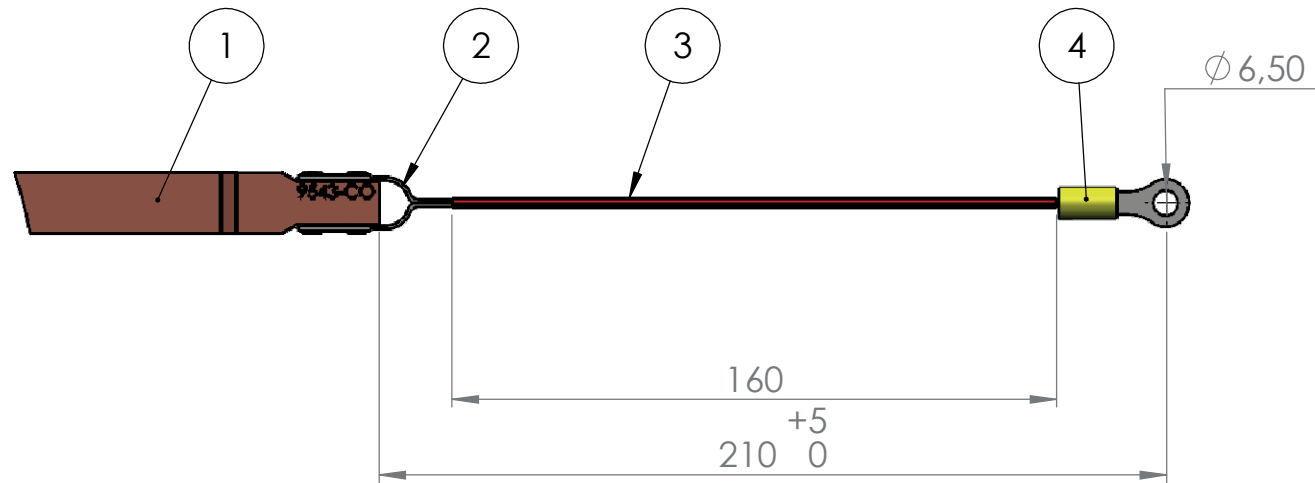

This document must not be copied without Carbox AB written permission, and the contents thereof must not be imparted to a third party nor be used for any unauthorized purpose. Contravention will be prosecuted.

REVISIONS				
ZONE	REV.	DESCRIPTION	DATE	APPROVED
-	A		2020-05-04	

Drawn By	Last Changed Date	Surface Treatment	General tolerance	CAD-System
	2020-05-04			
Approved By	Date	General Surface Roughn.	Material	Drawing Size
	2018-03-16			A4
			Title	Scale
			V90 Ground brush Vestas no: 753741	1:2
			Drawing No	Sheet
			9543-CO	2 (2)

